

Medidas TH-200 A

ALZADO

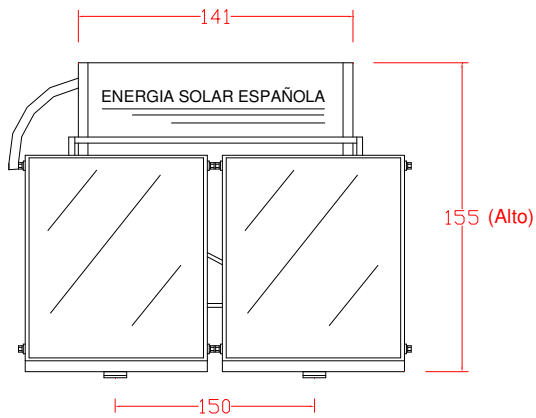

PERFIL

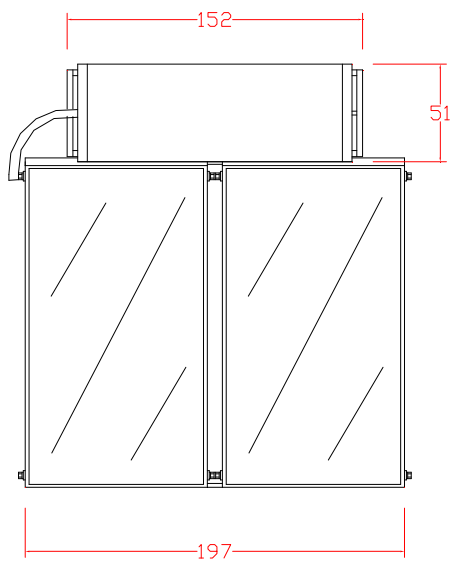
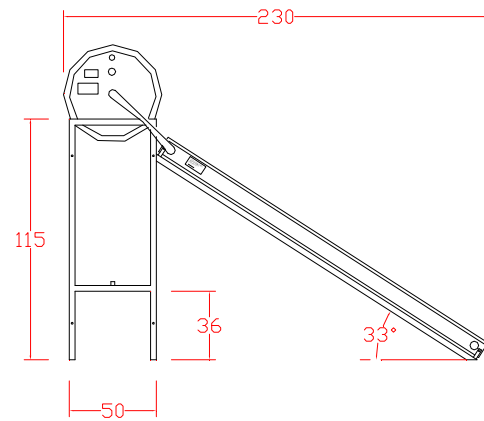

PLANTA

Medidas en cm.

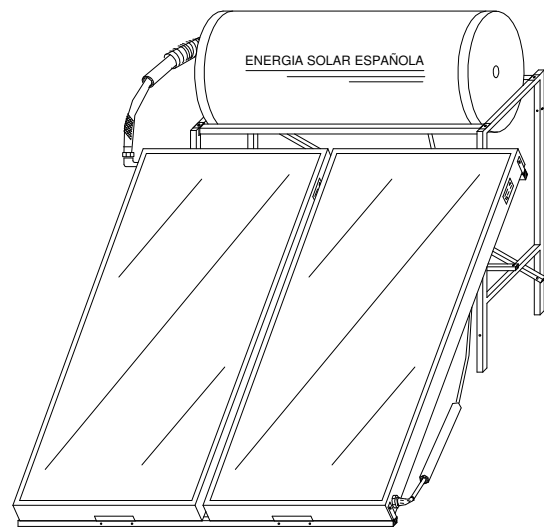

ISOMÉTRICO



Modelo	TH-200 A
<u>Depósito acumulador</u>	
Capacidad (litros)	200
Dimensiones (cm)	Largo: 141, Ø: 51
Peso (kg)	65
<u>Captador solar</u>	
Cantidad	2
Dimensiones (cm)	197x94x9
Superficie útil (m ²)	3,4 (2x1,7)
Peso (kg)	90 (2x45)
<u>Estructura</u>	
Material	Acero galvanizado en caliente
Peso (kg)	15
<u>Conjunto</u>	
Largo (cm)	197
Ancho (cm)	230
Alto (cm)	155
Presión max. (kg/cm ²)	7
Peso vacío (kg)	200
Peso lleno (kg)	400